

## Table of contents

---

Introduction .....	2
Waterproof design Warning .....	3
Key description.....	4
Key function .....	5
Display .....	5
Menu screen operation.....	6
Description othe menu features .....	6
DSC Menu.....	7
MMSI ID setup.....	8
Individual call Pos request, Group/Test call.....	8
All ship call.....	10
Receive call log .....	11
Send call log .....	11
Phone book .....	11
DSC setup .....	12
Distress Menu.....	12
Main Menu.....	13
VHF operation .....	13
GPS setting .....	14
System config .....	14
Key operation .....	15
Power ON/OFF Volume control .....	15
Special function key.....	15
SQL key.....	15
Up/Down key .....	15
16/9 key.....	15
Select the second priority channel .....	15
Hi/Lo/Lock key .....	16
CH/*/Wx key .....	16
SCAN key.....	16
MEM key .....	16
DW/Tri Watch key.....	17
MOB key.....	17
Backlight.....	17
Tx Time Out.....	17
Build in Battery .....	18
Connection Cable.....	18
Local Time & Date .....	19
Appendix A – Near Lightning Strike Test.....	20
Annexe B – Channel List .....	21
Declaration of conformity CE .....	28

# NAVICOM RT-420 DSC Instruction Manual

---

## Introduction

Your transmitter-receiver RT 420 DSC by Navicom was developed by using high technologies. Designed for an international use, it allows you to emit and to receive on all the international channels of the marine band VHF such as specified by the international union (ITU)

The device is a high-quality electronic equipment, builds according to the rule book with the best components, it answers all the standards of the market to supply you with clear and reliable communications.

Your transmitter-receiver is designed to supply reliable years of functioning, it thanks to a microprocessor with optimized performances.

Note: Within the framework of the directive WEEE, the end of life products must not be thrown by the user but dismissed.

## EU Regulatory Conformance

As certified by the qualified laboratory, the product is in compliance with the essential requirements and other relevant provisions of the Directive 1999/5/EC. Please note that the above information is applicable to EU countries only.

# CE 0678 !

## Waterproof design Warning:

This product is the IP67 waterproof design, in order to achieve the best performance, before the end-user use it, and please pay the highest attention for the following two points:

- 1, To tightening the antenna because there is an O-ring at the bottom of antenna side
- 2, To Cover tightly the mini USB cap because there is an O-ring design around the cap

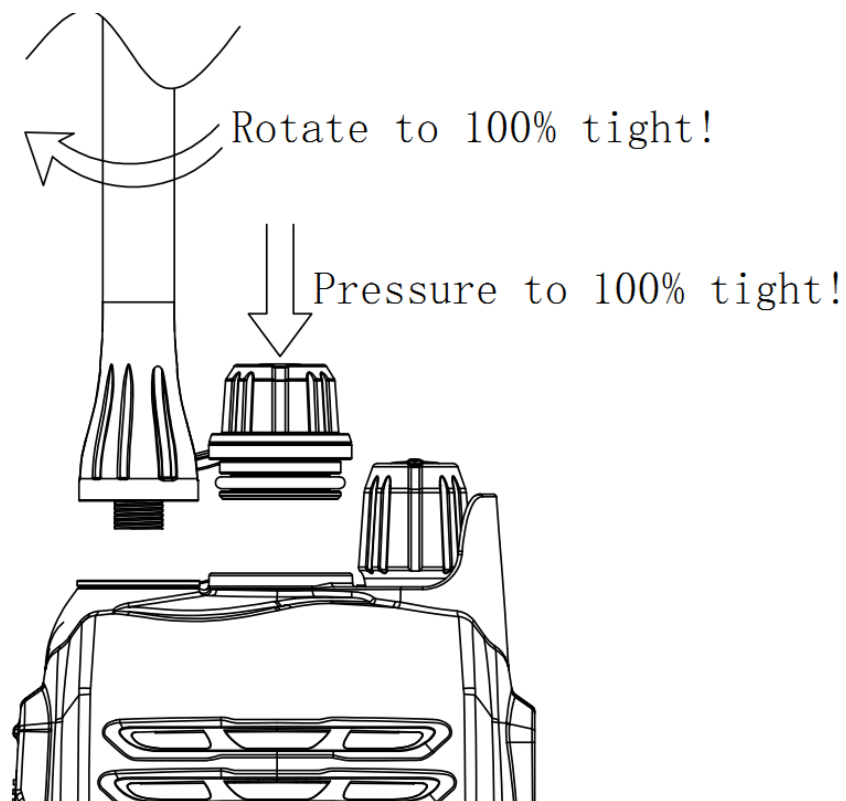

### Key description

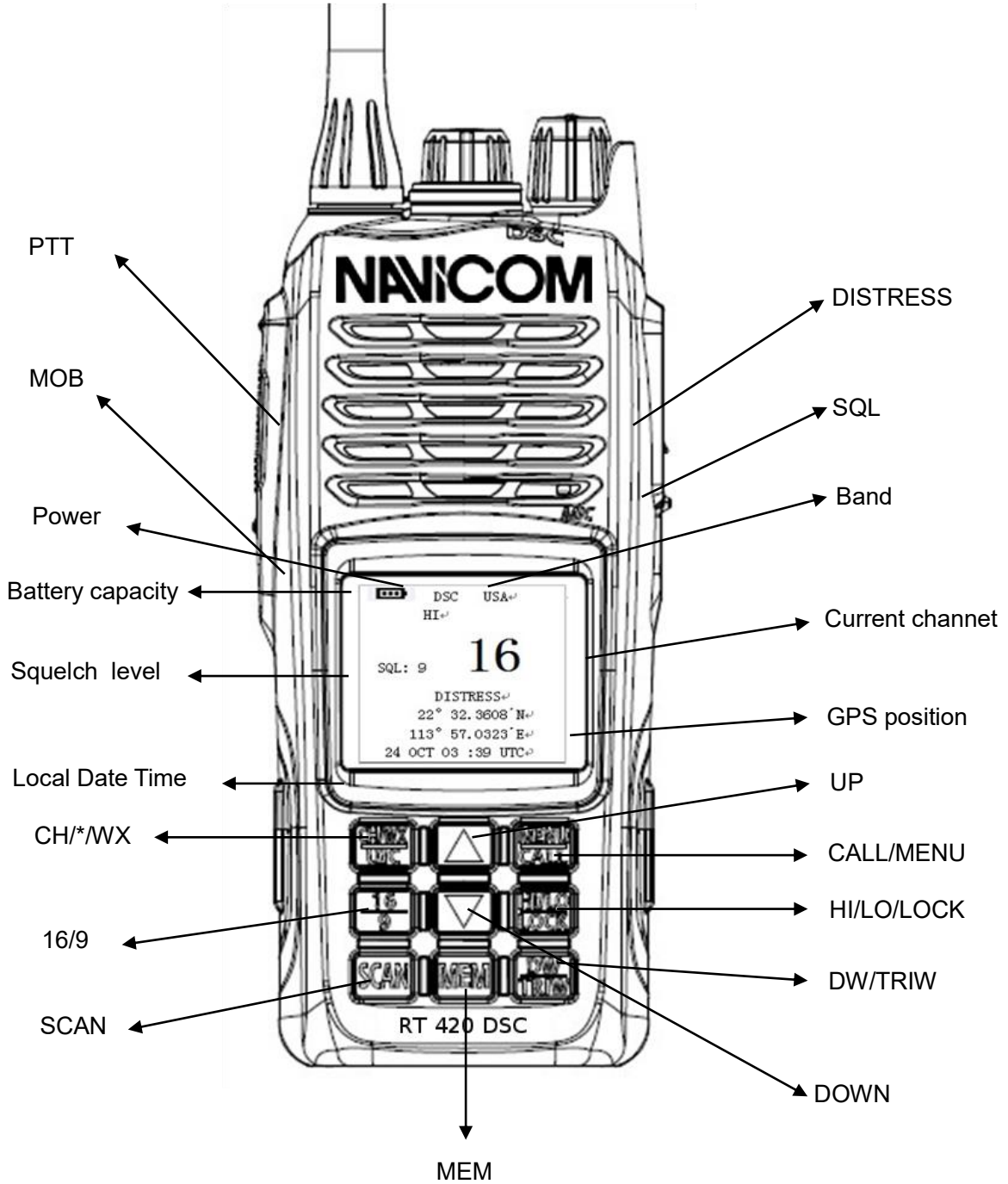

## Key function

Keys	Short press less than 3 seconds	Long press more than 3 seconds
HI/Lo /Lock	TX Power Hi/Low	Key Lock/key unlock
16/9	CH 16	CH09
DW/TriW	Dual Watch mode	Tri Watch mode
SCAN	All Scan/all memory Scan	Priority all/memory Scan
MEM	MEMORY Mode	Save/Delete Memory Channel
Up/Down	Channel/ Setting Up/Down	Channel up /down(much faster)
Menu/Call	DSC menu	Main menu
MOB		MOB activated
Distress	Distress menu	Distress alerty calling
SQL	Sql setting	Switch on/off Time& Date display
Volume Knob	Power ON / OFF Adjust the volume level	

## Display

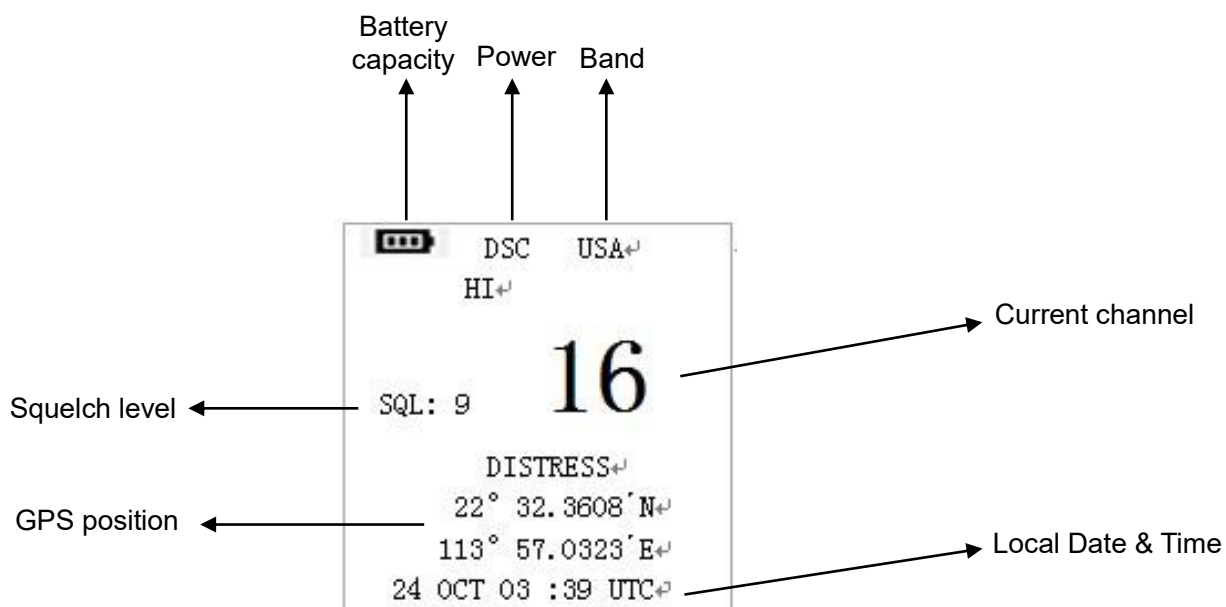

## Menu Screen Operation

The description on of the menu features

### Main Menu

VHF Operation	{ Channel Band Set Priority 2nd ch
GPS Setup	GPS Setting
ATIS Operation	{ My ATIS ID AITS Function
DSC Operation	{ My MMSI ID DSC Function
System Config	{ System Config LCD Back Light Back Light Time LCD Contrast Key Beep Version Info Factory Reset

### DSC Menu

Individual Call	{ Input Address From Phonebook
Position Request	{ Input Address From Phonebook
All Ship Call	{ Routine Safety Urgency
Group Call	{ Input Address From Phonebook
Test Call	{ Input Address From Phonebook

Receive Call Log {  Distress Call  
 Others Call

Send Call Log {  Distress Call  
 MOB Call  
 Others Call

Phone Book { Buddy List  
 Group List

DSC Setup { Position Input  
 Auto Ch Change  
 Position Reply  
 Test Ack

My MMSI ID { My MMSI ID  
 100000008

**DSC Menu:**

Short press the Call/Menu key will saw below DSC Menu as below.

DSC Menu  
 Individual Call  
 Position Request  
 All Ship Call  
 Group Call  
 Test Call  
 Receive Call Log  
 Send Call log  
 Phone Book  
 DSC Setup  
 My MMSI ID

Exit ▲▼ Enter

Then the CH/\*/WX key will became the Exit key and the Call/Menu key will became the Enter key. The UP/DOWN key function has the same function to choose the item at the menu without the changes.

**For My MMSI ID setup**

Firstly, set up the MMSI ID, to click the My MMSI ID and Enter, then you are able to set up your related MMSI ID as below generally you need to double confirm the MMSI ID then your MMSI ID will be locked by this radio.



When you input 9 digits, UP/DOWN key to choose the number from 1-9, you need to input all numbers from the left to right one by one. When you input all 9 digits then press the enter to confirm.

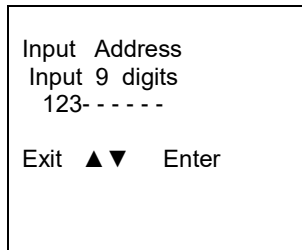

After you enter 123000001 these nine figures, the screen will be displayed as below

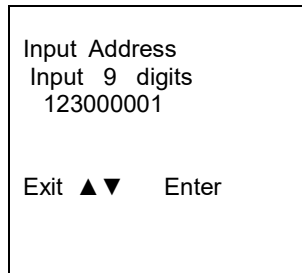

**for Individual Call, Position Request, Group Call and Test Call.**

Click the preferred item then you are able to find the target MMSI ID to call by Input Address or From Phonebook. We take the individual call as an example.

When you selected the input address item to click and input 9 digits such as the 10000000 for your address as below.

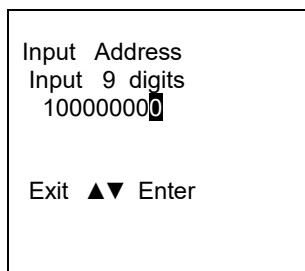



Then select the type of individual call such as the safety

```

Individual Call
Routine
Safety
Urgency

Exit ▲▼ Enter
    
```

Then select the channels such as the 01 port operation then confirm to call

```

Individual Call
Select Channel:
01 port ops/vts
03 unauthorized
05 port ops/vts
06 inter ship
07 commercial
08 commercial
Exit ▲▼ Enter
    
```

Then the individual call is sent

```

Individual Call
To: 100000000
Safety
Telephony by
Channel 01

Exit Call
    
```

Then the individual call is sent

```

DSC USA
LO SQL:5

01A

PORT OPERAT/UTS
Elapsed 00: 12
Exit
    
```

**for All Ship Call:**

Select the All Ship Call item

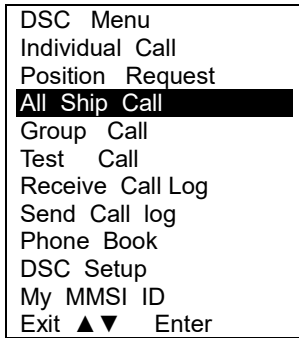

Then select the type of All Ship Call such as the Urgency

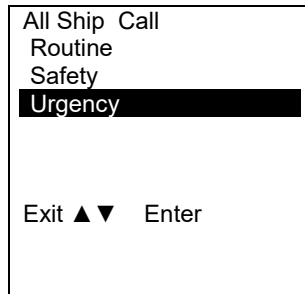

Then select the channels such as the 07 Commercial then confirm to call

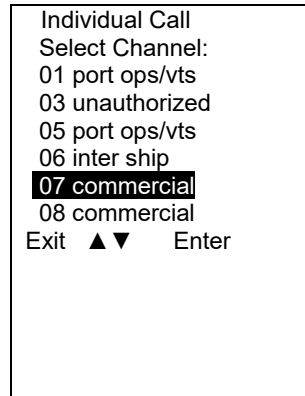

Then the All Ship Call is sent

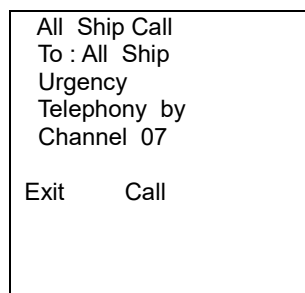

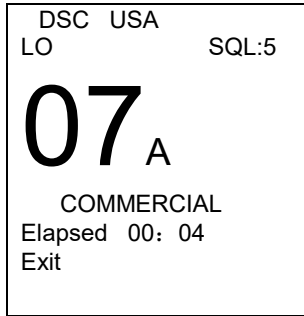

**Receive Call Log**

When receive the DSC call and you able to check the message from the Distress Call then able to see the exact message.

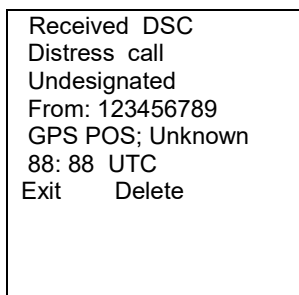
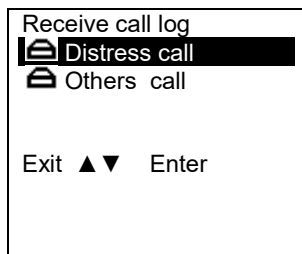
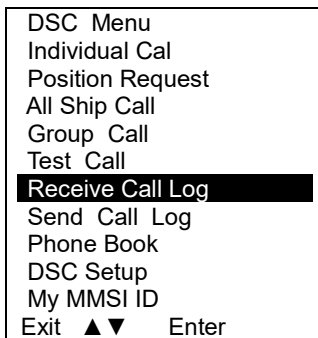

**Send Call Log**

To press the Send Call Log able to saw the previous Distress Call MOB Call and Other Call you have sent

**Phone Book:**

Able to check the contact ship by Buddy list and Group list

**DSC Setup**

The DSC setup menu got the 4 item to choose as the Position Input, Auto Ch Change, Position Reply and Test Ack.

For Position Input you can set up the GPS position and UTC time by manual operation.

For Auto Ch Change, Position Reply and Test Ack you can choose the Automatic or Manual by you interests.

**Distress Menu:**

Pull the Distress red cover then press the Distress key You are able to saw the Distress Menu in below.

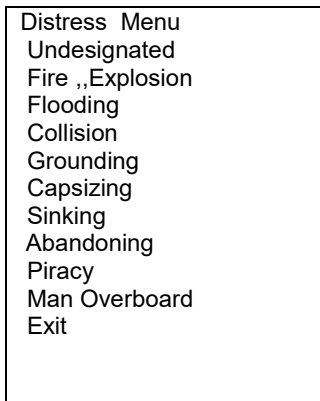

**Send the distress Message:**

Choose one distress item such as the Sinking the press and hold the distress key for 3 seconds the Sinking distress message will be sent.

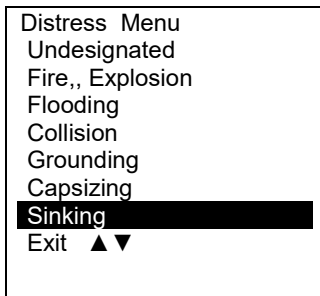

You also able to choose to resend pause or Exit after the message be sent.

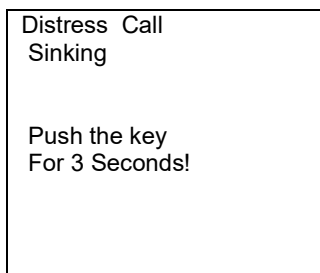

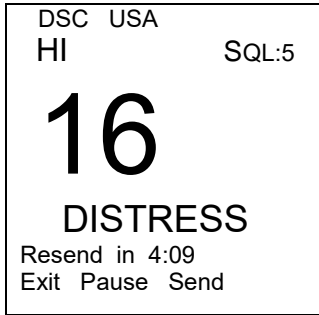

**Main Menu:**

Long press the Call/Menu key will saw below Main Menu as below.

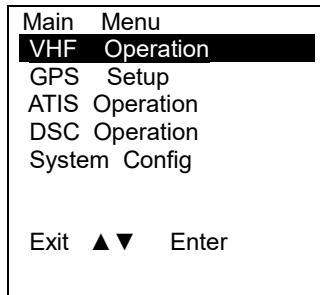

**For VHF Operation:**

Select the VHF operation to enter will see Channel Band Set and Priority 2nd Ch options in below

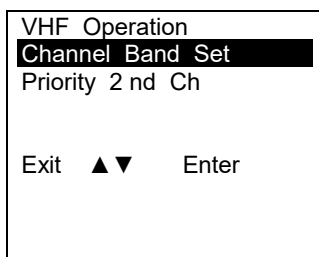

For VHF Operation, you are able to choose the wanted channel band from those three options USA, INT and CAN.

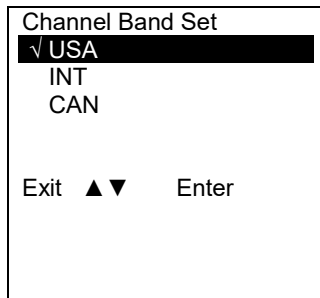

For Priority 2nd Ch you can select you wanted priority 2nd channel.

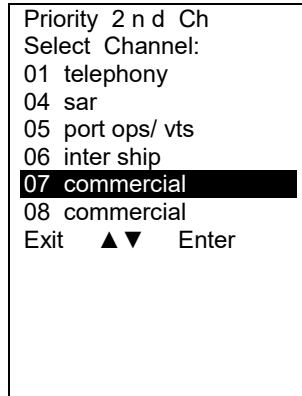

**For GPS Setting:**

You are able to setup the Time Display and Time Offset More detail able to see the 5.4 (4) the local time and date on screen:

**For System Config:**

Select the system Config and you are able to see the below menu to check and adjust the LCD/Key Beep figure, version info and factory reset.

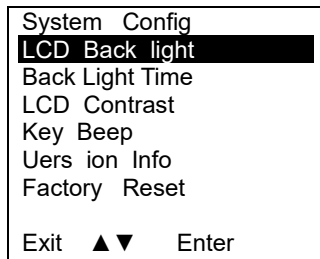

## KEY OPERATION

### Power ON/OFF & Volume Control

Turn the Volume knob clockwise until a click sound heard, the unit will power on

### Volume Control:

Turn the Volume knob: Clockwise-volume up, Counter-clockwise-volume down.

### Special function: Distress Key and Real DSC

Send the Distress message:

Pull the Distress key cover then able to Press the Red key into the Distress Menu selection. Then select the current distress situation such as the "Flooding" then press and hold for 3 seconds, the selected DSC message will be send.

This message also will be resend within 4 mines, press the Up key will pause or resume the resend, press Call/Menu key will resend immediately. Press the CH/\*/WX key will exit the current menu and give the option on cancel of this selected distress alert.

Receive the Distress message:

The HM360 model has two receivers, one receiver used for receiving/transmit voice and another receiver used for to continually monitor 70 channels. The DSC function for HM360 model is operated by individual way. Even you are using the HM360 to make the transmit or receive, when the DSC message is arrived. The HM360 handheld model always can receive all of the DSC message as a fixed mounted marine radio.

Press the Call/Menu key and select the receive call log then press the enter to see all received DSC message.

### SQL key

Short press the SQL key then press the Up/Down key to select squelches level accordingly. Then short press the SQL key to exit the squelch level adjustment.

Long press SQL key, then move into GPS feature, press up/down key to see COG/SOG and the GPS signal via the current satellite.

To select the kilometer and Knots, long press call/menu key then select the GPS setup, then choose the GPS setting, then choose the speed unit, then you able to choose knots/km.

Once select then exit and the radio will keep your last choice.

### Up/Down key

At the normal mode, they act as Channel Up/Down key. When it press > 0.5 sec, the channels will change in a quick way. It returns to normal mode when key press is released.

### 16/9 key

At the normal mode ,pressing the 16 / 9 Key (short press to jump to priority CH16 at High Power and long press to jump to priority CH9 at High Power) if the current channel is not the priority channel

After the channel is tuned to the priority channel, the "P-CH" and "P-2nd" icon is lit to indicate that the priority CH16 or CH9 has been reached. UP/Down key functions normally.

### Select the second priority channel

Change the second priority channel by 16/9 key: normally the second priority channel is initially sets as the channel 9. At the normal mode, Long press the 16 / 9 Key will display the second priority channel as channel 9. Then long press the 16 / 9 Key again and the "2nd Prior" icon will display on the screen. Using the UP/Down key to choose your prefer channel as the second priority channel then

long press the 16 / 9 Key to confirm it

Change the second priority channel by Menu key: Press the 16 / 9 Key then press the Call/ Main key to select VHF operation option then press Enter to select the Priority 2nd Ch then press Enter and select you preferred channel by Up/Down Key then press Enter to confirm

## Hi/Lo/Lock Key

Short press the Hi/Lo/LOCK key will toggle the TX power from Hi to Lo or vice versa. The corresponding "HI or Lo" icon will turn on to display on the LCD.

Some of the channel such as channel 16 only for high power/channel 13&67 only for low power) has been limited to be low power only or high power only. Thus, the software needs to check against the channel setting stored in the EEPROM

Long press the Hi/Lo/LOCK key will lock the keys and the "lock key" icon, then all of the key will be locked to use except the PPT key and Distress key /related distress function. Long press the Hi/Lo/LOCK key again to cancel the lock mode and the "lock key" icon will disappear.

## Ch/ \*/Wx key

Short press CH/\*/WX key will enter private mode if there are same private channel in the EEPROM. The "PRIVATE" icon will display on the screen. Press Up/Down key to change private channel., If there aren't any private channel in the EEPROM, the "--" icon will display on the screen.

### Weather Band:

Long press the CH/\*/WX key will enter WX mode when the current operational channel band is USA or Canada. When Dual or Tri watch is being activated in the Wx mode, the watch will monitor the current WX channel and priority channel(s).

## Scan Key

This is the function to scan for currently working channels. When a signal is detected, the scan pauses until the signal disappears.

Short press the Scan Key, to activate the SCAN function. Scan all channels.

Long press the Scan Key, to activate the Priority Scan.

## MEM Key

Enter /Exit the memory mode:

Short press the MEM key to enter the memory mode, the memory channel will mark as the "M" icon at the right side of channel number. At the left side of the current channel will mark as the "user" icon means as already enter the user memory mode.

At the Memory mode, short press the MEM key to exit the memory mode. The "M" icon ( at the right side of channel number) and the "user" icon (at the left side of the current channel) will disappear.

Adding/Deleting memory CH:

During the normal mode, use the UP/DOWN key to select the desired channel for programming.

Long press the MEM key to store up the channel as memory channel.

The "M" icon at the right side of current channel number will shows up to indicate the current CH has been saved in the memory. No limited of memory channels.

Separate memory channel exists for USA, International, and Canadian Frequency group.

During the normal mode, use the UP/DOWN key to select the memory channel to be deleted.

Long press the MEM key to delete the selected channel from the memory.



## **DW/TriW key (Dual Watch/Tri Watch)**

At the normal mode, short press DW/TRIW key to activate the DUAL WATCH mode. Monitor the current channel and Ch 16 in cycle. Whenever, Weather Alert is activated, the Wx Alert channel will be monitored once every 4sec.

Long press DW/TRI key to activate the TRI WATCH mode. Monitor the Ch 16, current channel and 1 programmed channels in cycle.

## **MOB key**

Long press the MOB key will activate the MOB function. The radio will send a MOB call with its MMSI and latitude and longitude.

## **Backlight**

Any key press will turn on the backlit (if backlit setting is ON ) except the PTT key. The backlit should be remaining on for 5 seconds if no any keys pressed. The time out will be reset if any key pressed within the time frame.

## **TX Time Out**

The transmission will be automatically turn off after PTT key pressed over 5 consecutive minutes. The TX mode will be terminate and back to Rx mode. To indicate the PTT key as the stuck condition. Once the PTT key is released, the TX time out timer will be reset. PTT key will work back normally.

## Build in Battery

The RT-420 DSC model has the Build in Battery design like the iPhone there are three steps to installation and removal the battery in below diagram.

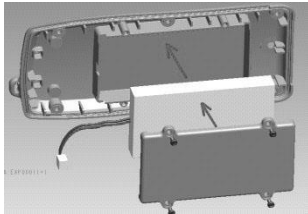

**Step1**



**Step2**

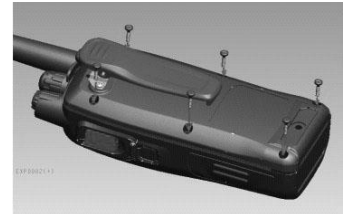

**Step3**

## Connection Cable

Due to the RT-420 got the build in battery. Therefore, we do place the IP68 connection cable (1.5 meter length) for power charger. It also used for the software update and automatic test in manufacture stage.

For Power charger:

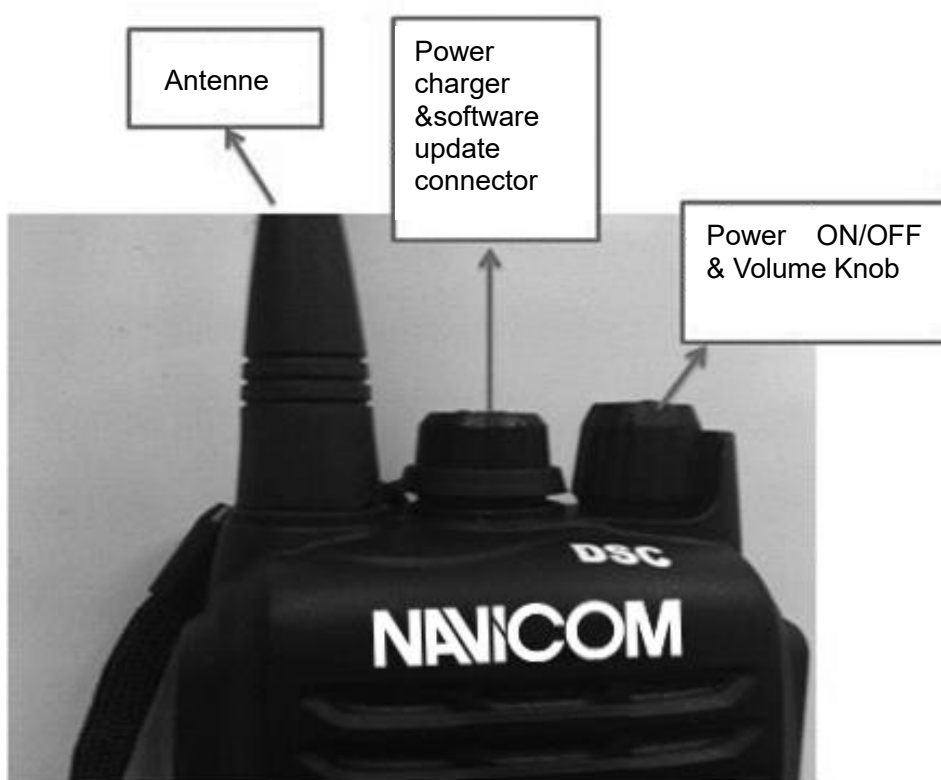

**The local time and date on screen:**

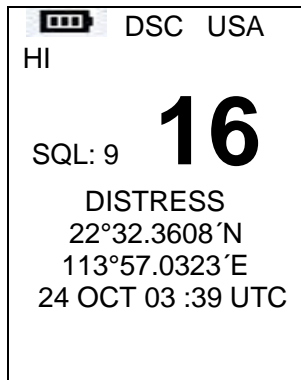

UTC TIME



LOCAL TIME

When the HM360 cannot receive the GPS signal to display the current position, the screen will automatic display the UTC local time and date.

Long press the SQL key will switch on/off Time Date display. When the radio received the GPS signal, the screen will display the current GPS location and related UTC time and date below the GPS location mark.

The user can press the menu to switching your local time based on the UTC time. Long press the Call/Menu key then select the GPS setup item to enter. Then you can saw the GPS setting item and click the enter to select the Time offset item Then you are able to adjust your location time based on the time difference with the UTC time then press the enter to confirm. (You need to pass the entire item from the hour-minutes –seconds then able to saw the enter option to click and confirm).

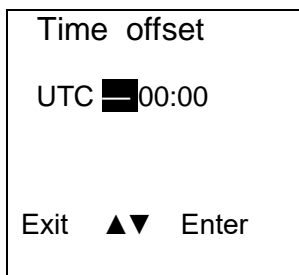

## Appendix A – Near Lightning Strike Test

This appendix describes the general procedure for evaluating the immunity to near lightning strikes (NLS) of the RT-420DSC VHF Radio.

The test simulates a slow, high-energy pulse produced by an NLS event.

### Related External Documents

- **BS EN 61000-4-5 : 2006**
- **EMC Directive 2004/108/EC**

### List of Abbreviations

<b>AE</b>	Auxiliary Equipment
<b>CE</b>	Conducted Emissions
<b>EMC</b>	Electromagnetic Compatibility
<b>EN</b>	European Norm
<b>EUT</b>	Equipment Under Test
<b>FTB</b>	Fast Transient Burst
<b>MED</b>	Marine Equipment Directive
<b>QP</b>	Quasi Peak

### Safety

The high voltage interference pulse can contain a very large quantity of energy and every precaution shall be taken to avoid contact with EUT during a test. It is highly recommended that at least one other person is present (or very close by) during the test.

### Test Configuration

#### EUT Setup

The EUT shall be setup in a typical system configuration on an isolated wooden bench with NO GROUNDPLANE. The power to the EUT and auxiliary equipment shall be from 12V or 24V sealed lead-acid batteries via a suitable fuse. The length of the EUT power cable shall be no more than 2m. Any screens within the system shall be terminated at the battery very connection.

#### EUT Operating Configuration

All operating configurations should be tested with appropriate performance criteria defined for each test.

### Performance Criteria

From BS EN 61000-4-5 : 2006

Performance criteria C: Temporary loss of function or degradation of performance, the correction of which requires operator intervention.

## Appendix B – Channel List

### International Marine VHF Channels & Frequencies

CH No.	XMIT Freq	RCV Freq	Single	Freq Use
01	156.050	160.650		Public Correspondence, Port Operations and Ship Movement
02	156.100	160.700		Public Correspondence, Port Operations and Ship Movement
03	156.150	160.750		Public Correspondence, Port Operations and Ship Movement
04	156.200	160.800		Public Correspondence, Port Operations and Ship Movement
05	156.250	160.850		Public Correspondence, Port Operations and Ship Movement
06	156.300	156.300	x	Intership 1
07	156.350	160.950		Public Correspondence, Port Operations and Ship Movement
08	156.400	156.400	x	Intership
09	156.450	156.450	x	Intership, Port Operations and Ship Movement
10	156.500	156.500	x	Interships, Port Operations and Ship Movement 2
11	156.550	156.550	x	Port Operations and Ship Movement
12	156.600	156.600	x	Port Operations and Ship Movement
13	156.650	156.650	x	Intership Safety, Port Operations and Ship Movement 3
14	156.700	156.700	x	Port Operations and Ship Movement
15	156.750	156.750	x	Intership and On-board Communications at 1W only 4
16	156.800	156.800	x	Distress, Safety and Calling
17	156.850	156.850	x	Intership and On-board Communications at 1W only 4
18	156.900	161.500		Public Correspondence, Port Operations and Ship Movement
19	156.950	161.550		Public Correspondence, Port Operations and Ship Movement
20	157.000	161.600		Public Correspondence, Port Operations and Ship Movement
21	157.050	161.650		Public Correspondence, Port Operations and Ship Movement
22	157.100	161.700		Public Correspondence, Port Operations and Ship Movement
23	157.150	161.750		Public Correspondence, Port Operations and Ship Movement
24	157.200	161.800		Public Correspondence, Port Operations and Ship Movement
25	157.250	161.850		Public Correspondence, Port Operations and Ship Movement
26	157.300	161.900		Public Correspondence, Port Operations and Ship Movement
27	157.350	161.950		Public Correspondence, Port Operations and Ship Movement
28	157.400	162.000		Public Correspondence, Port Operations and Ship Movement
60	156.025	160.625		Public Correspondence, Port Operations and Ship Movement
61	156.075	160.675		Public Correspondence, Port Operations and Ship Movement
62	156.125	160.725		Public Correspondence, Port Operations and Ship Movement
63	156.175	160.775		Public Correspondence, Port Operations and Ship Movement
64	156.225	160.825		Public Correspondence, Port Operations and Ship Movement
65	156.275	160.875		Public Correspondence, Port Operations and Ship Movement
66	156.325	160.925		Public Correspondence, Port Operations and Ship Movement
67	156.375	156.375	x	Intership, Port Operations and Ship Movement 2
68	156.425	156.425	x	Port Operations and Ship Movement
69	156.475	156.475	x	Intership, Port Operations and Ship Movement
71	156.575	156.575	x	Port Operations and Ship Movement
72	156.625	156.625	x	Intership
73	156.675	156.675	x	Intership 2
74	156.725	156.725	x	Port operations and Ship movement
75	156.775	156.775	x	See Note 5
76	156.825	156.825	x	See Note 5
77	156.875	156.875	x	Intership
78	156.925	161.525		Public correspondence, Port Operations and Ship Movement
79	156.975	161.575		Public correspondence, Port Operations and Ship Movement
80	157.025	161.625		Public correspondence, Port Operations and Ship Movement
81	157.075	161.675		Public correspondence, Port Operations and Ship Movement
82	157.125	161.725		Public correspondence, Port Operations and Ship Movement
83	157.175	161.775		Public correspondence, Port Operations and Ship Movement
84	157.225	161.825		Public correspondence, Port Operations and Ship Movement
85	157.275	161.875		Public correspondence, Port Operations and Ship Movement
86	157.325	161.925		Public correspondence, Port Operations and Ship Movement
87	157.375	157.375	x	Port Operations and Ship Movement
88	157.425	157.425	x	Port Operations and Ship Movement

- Intership channels are for communications between ship stations. Intership communications should be restricted to Channels 6, 8, 72 and 77. If these are not available, the other channels marked for Intership may be used.
- Channel 70 is used exclusively for Digital Selective Calling (DSC) and is not available for regular voice communications.

**Notes:**

1. Channel 06 may also be used for communications between ship stations and aircraft engaged incoordinated search and rescue operations. Ship stations should avoid harmful interference to such communications on channel 06 as well as to communications between aircraft stations, ice breakers and assisted ships during ice seasons.
2. Within the European Maritime Area and in Canada, channels 10, 67 and 73 may also be used by the individual administrations concerned for communication between ship stations, aircraft stations and participating land stations engaged in coordinated search and rescue and anti-pollution operations in local areas. Channels 10 or 73 (depending on location) are also used for the broadcast of Marine Safety Information by the Maritime and Coast Guard Agency in the UK only.
3. Channel 13 is designated for use on a worldwide basis as a navigation safety communication channel, primarily for intership navigation safety communications.
4. Channels 15 and 17 may also be used for on-board communications provided the effective radiated power does not exceed 1 Watt.
5. The use of Channels 75 and 76 should be restricted to navigation related communication only and all precautions should be taken to avoid harmful interference to channel 16. Transmit power is limited to 1 Watt.

## U.S. Marine VHF Channels and Frequencies

CH. No	XMIT Freq	RCV Freq	Single	Freq Use
01A	156.050	156.050	x	Port Operations and Commercial, VTS. Available only in New Orleans / Lower Mississippi area. 1
03A	156.150	156.150	x	U.S. Government only
05A	156.250	156.250	x	Port Operations or VTS in the Houston, New Orleans and Seattle areas.
06	156.300	156.300	x	Intership Safety
07A	156.350	156.350	x	Commercial
08	156.400	156.400	x	Commercial (Intership only)
09	156.450	156.450	x	Boater Calling. Commercial and Non-Commercial.
10	156.500	156.500	x	Commercial
11	156.550	156.550	x	Commercial. VTS in selected areas.
12	156.600	156.600	x	Port Operations. VTS in selected areas.
13	156.650	156.650	x	Intership Navigation Safety (Bridge-to-bridge). Ships >20meters in length maintain a listening watch on this channel in US waters. 2, 6
14	156.700	156.700	x	Port Operations. VTS in selected areas.
15	-	156.750	x	Environmental (Receive only). Used by Class 'C' EPIRBs.3
16	156.800	156.800	x	International Distress, Safety and Calling. Ships required to carry radio, USCG, and most coast stations maintain a listening watch on this channel. 4
17	156.850	156.850	x	State Control 5
18A	156.900	156.900	x	Commercial
19A	156.950	156.950	x	Commercial
20	157.000	161.600		Port Operations (duplex)
20A	157.000	157.000	x	Port Operations
21A	157.050	157.050	x	U.S. Coast Guard only
22A	157.100	157.100	x	Coast Guard Liaison and Maritime Safety Information Broadcasts. Broadcasts announced on channel 16.
23A	157.150	157.150	x	U.S. Coast Guard only
24	157.200	161.800		Public Correspondence (Marine Operator)
25	157.250	161.850		Public Correspondence (Marine Operator)
26	157.300	161.900		Public Correspondence (Marine Operator)
27	157.350	161.950		Public Correspondence (Marine Operator)
28	157.400	162.000		Public Correspondence (Marine Operator)
61A	156.075	156.075	x	U.S. Government only
63A	156.175	156.175	x	Port Operations and Commercial, VTS. Available only in New Orleans / Lower Mississippi area.
64A	156.225	156.225	x	U.S. Coast Guard only

65A	156.275	156.275	x	Port Operations
66A	156.325	156.325	x	Port Operations
67	156.375	156.375	x	Commercial. Used for Bridge-to-bridge communications in lower Mississippi River. Intership only. 6
68	156.425	156.425	x	Non-Commercial
69	156.475	156.475	x	Non-Commercial
71	156.575	156.575	x	Non-Commercial
72	156.625	156.625	x	Non-Commercial (Intership only)
73	156.675	156.675	x	Port Operations
74	156.725	156.725	x	Port Operations
77	156.875	156.875	x	Port Operations (Intership only) 5
78A	156.925	156.925	x	Non-Commercial
79A	156.975	156.975	x	Commercial. Non-Commercial in Great Lakes only.
80A	157.025	157.025	x	Commercial. Non-Commercial in Great Lakes only
81A	157.075	157.075	x	U.S. Government only – Environmental protection operations.
82A	157.125	157.125	x	U.S. Government only
83A	157.175	157.175	x	U.S. Coast Guard only
84	157.225	161.825		Public Correspondence (Marine Operator)
85	157.275	161.875		Public Correspondence (Marine Operator)
86	157.325	161.925		Public Correspondence (Marine Operator)
87	157.375	161.975		Public Correspondence Marine Operator)
88	157.425	162.025		Public Correspondence only near Canadian border
88A	157.425	157.425	x	Commercial, Intership only

- Recreational boaters normally use channels listed as Non-Commercial: 68, 69, 71, 72, 78A.
- Channel 70 is used exclusively for Digital Selective Calling (DSC) and is not available for regular voice communications.
- Channels 75 and 76 are reserved as guard bands for Channel 16 and are not available for regular voice communications.

Notes:

1. The letter "A" following a channel number indicates simplex use of the ship station transmit side of an international semi-duplex channel. Operations are different from that of international operations on that channel.
2. Channel 13 should be used to contact a ship when there is danger of collision. All ships of length 20 meters or greater are required to guard VHF channel 13, in addition to VHF channel 16, when operating within U.S. territorial waters.
3. Channel is Receive Only.
4. Channel 16 is used for calling other stations or for distress alerting.
5. Output power is fixed at 1 watt only.
6. Output power is initially set to 1 watt. User can temporarily override this restriction to transmit at high power.

## Canadian Marine VHF Channels and Frequencies

CH No.	XMIT Freq	RCV Freq	Area of Operation Use
01	156.050	160.650	PC Public Correspondence
02	156.100	160.700	PC Public Correspondence
03	156.150	160.750	PC Public Correspondence
04A	156.200	156.200	PC Intership, Ship/Shore and Safety: Canadian Coast Guard S&R
04A	156.200	156.200	EC Intership, Ship/Shore and Commercial: Commercial fishing only
05A	156.250	156.250	Ship Movement
06	156.300	156.300	All areas Intership, Commercial, Non-commercial and Safety: May be used for search and rescue communications between ships and aircraft.
07A	156.350	156.350	All areas Intership, Ship/Shore, Commercial
08	156.400	156.400	WC, EC Intership, Commercial and Safety: Also assigned for operations in the Lake Winnipeg area.
09	156.450	156.450	AC Intership, Ship/Shore, Commercial, Non-commercial and Ship Movement: May be used to communicate with aircraft and helicopters in predominantly maritime support operations.
10	156.500	156.500	AC, GL Intership, Ship/Shore, Commercial, Non-commercial, Safety and Ship Movement: May also be used for communications with aircraft engaged in coordinated search and rescue and antipollution operations.
11	156.550	156.550	PC, AC, GL Intership, Ship/Shore, Commercial, Non-commercial and Ship Movement: Also used for pilotage purposes.
12	156.600	156.600	WC, AC, GL Intership, Ship/Shore, Commercial, Non-commercial and Ship Movement: Port operations and pilot information and messages.
13	156.650	156.650	All areas Intership, Commercial, Non-commercial and Ship Movement: Exclusively for bridge-to-bridge navigational traffic. Limited to 1-watt maximum power.
14	156.700	156.700	AC, GL Intership, Ship/Shore, Commercial, Non-commercial and Ship Movement: Port operations and pilot information and messages.
15	156.750	156.750	All areas Intership, Ship/Shore, Commercial, Non-commercial and Ship Movement: All operations limited to 1-watt maximum power. May also be used for on-board communications.
16	156.800	156.800	All areas International Distress, Safety and Calling <sup>2</sup>
17	156.850	156.850	All areas Intership, Ship/Shore, Commercial, Non-commercial and Ship Movement: All operations limited to 1-watt maximum power. May also be used for on-board communications.
18A	156.900	156.900	All areas Intership, Ship/Shore and Commercial: Towing on the Pacific Coast.
19A	156.950	156.950	All areas except PC Intership and Ship/Shore: Canadian Coast Guard only.
19A	156.950	156.950	PC Intership and Ship/Shore: Various Government departments
20	157.000	161.600	All areas Ship/Shore, Safety and Ship Movement: Port operations
21A	157.050	157.050	All areas Intership and Ship/Shore: Canadian Coast Guard only.
21B	-	161.650	All areas Safety: Continuous Marine Broadcast (CMB) service. <sup>3</sup>
22A	157.100	157.100	All areas Intership, Ship/Shore, Commercial and Non-commercial: For communications between Canadian Coast Guard and non-Canadian Coast Guard stations only.
23	157.150	161.750	PC Ship/Shore and Public Correspondence: Also in the inland waters of British Columbia and the Yukon.
24	157.200	161.800	All areas Ship/Shore and Public Correspondence
25	157.250	161.850	PC Ship/Shore and Public Correspondence: Also assigned for operations in the Lake Winnipeg area.
25B	-	161.850	AC Safety: Continuous Marine Broadcast (CMB) service.
26	157.300	161.900	All areas Ship/Shore, Safety and Public Correspondence



27	157.350	161.950	AC, GL, PC Ship/Shore and Public Correspondence
28	157.400	162.000	PC Ship/Shore, Safety and Public Correspondence
28B	-	162.000	AC Safety: Continuous Marine Broadcast (CMB) service.
60	156.025	160.625	PC Ship/Shore and Public Correspondence
61A	156.075	156.075	PC Intership and Ship/Shore: Canadian Coast Guard only.
61A	156.075	156.075	EC Intership, Ship/Shore and Commercial: Commercial fishing only.
62A	156.125	156.125	PC Intership and Ship/Shore: Canadian Coast Guard only.
62A	156.125	156.125	EC Intership, Ship/Shore and Commercial: Commercial fishing only.
64	156.225	160.825	PC Ship/Shore and Public Correspondence
64A	156.225	156.225	EC Intership, Ship/Shore and Commercial: Commercial fishing only.
65A	156.275	156.275	Intership, Ship/Shore, Commercial, Non-commercial, Safety: Search & rescue and antipollution operations on the Great Lakes. Towing on the Pacific Coast. Port operations only in the St. Lawrence River areas with 1W maximum power. Pleasure craft in the inland waters of Alberta, Saskatchewan and Manitoba (excluding Lake Winnipeg and the Red River).
66A	156.325	156.325	Intership, Ship/Shore, Commercial, Non-commercial, Safety and Ship Movement: Port operations only in the St. Lawrence River/Great Lakes Areas with 1-watt maximum power.
67	156.375	156.375	EC Intership, Ship/Shore and Commercial: Commercial fishing only.
67	156.375	156.375	All areas except EC Intership, Ship/Shore, Commercial, Non-commercial, Safety: May also be used for communications with aircraft engaged in coordinated search and rescue and antipollution operations.
68	156.425	156.425	All areas Intership, Ship/Shore and Non-commercial: For marinas and yacht clubs.
69	156.475	156.475	All areas except EC Intership, Ship/Shore, Commercial and Non-commercial
69	156.475	156.475	EC Intership, Ship/Shore and Commercial: Commercial fishing only.
71	156.575	156.575	PC Intership, Ship/Shore, Commercial, Non-commercial, Safety and Ship Movement
71	156.575	156.575	Intership, Ship/Shore and Non-commercial: For marinas and yacht clubs on the East Coast and on Lake Winnipeg.
72	156.625	156.625	EC, PC Intership, Commercial and Non-commercial: May be used to communicate with aircraft and helicopters in predominantly maritime support operations.
73	156.675	156.675	EC Intership, Ship/Shore and Commercial: Commercial fishing only
73	156.675	156.675	All areas except EC Intership, Ship/Shore, Commercial, Non-commercial, Safety: May also be used for communications with aircraft engaged in coordinated search and rescue and antipollution operations.
74	156.725	156.725	EC, PC Intership, Ship/Shore, Commercial, Non-commercial and Ship Movement.
77	156.875	156.875	Intership, Ship/Shore, Safety and Ship Movement: Pilotage on Pacific Coast. Port operations only in the St. Lawrence River/Great Lakes areas with 1W maximum power.
78A	156.925	156.925	EC, PC Intership, Ship/Shore and Commercial
79A	156.975	156.975	EC, PC Intership, Ship/Shore and Commercial
80A	157.025	157.025	EC, PC Intership, Ship/Shore and Commercial
81A	157.075	157.075	Intership and Ship/Shore: Canadian Coast Guard use only in the St. Lawrence River/Great Lakes areas.
81A	157.075	157.075	PC Intership, Ship/Shore and Safety: Canadian Coast Guard antipollution.
82A	157.125	157.125	PC Intership, Ship/Shore and Safety: Canadian Coast Guard use only.
82A	157.125	157.125	Intership and Ship/Shore: Canadian Coast Guard use only in the St. Lawrence River/Great Lakes areas.
83	157.175	161.775	PC Ship/Shore and Safety: Canadian Coast Guard use only.
83A	157.175	157.175	EC Intership and Ship/Shore: Canadian Coast Guard and other Government agencies.

83B	-	161.775	AC, GL Safety: Continuous Marine Broadcast (CMB) Service.
84	157.225	161.825	PC Ship/Shore and Public Correspondence
85	157.275	161.875	AC, GL, NL Ship/Shore and Public Correspondence
86	157.325	161.925	PC Ship/Shore and Public Correspondence
87	157.375	161.975	AC, GL, NL Ship/Shore and Public Correspondence
88	157.425	162.025	AC, GL, NL Ship/Shore and Public Correspondence

AC: Atlantic Coast, Gulf and St. Lawrence River up to and including Montreal

EC (East Coast): includes NL, AC, GL and Eastern Arctic areas

GL: Great Lakes (including St. Lawrence above Montreal)

NL: Newfoundland and Labrador

PC: Pacific Coast

WC (West Coast): Pacific Coast, Western Arctic and Athabasca-Mackenzie Watershed areas

All areas: includes East and West Coast areas

Notes:

1. An "A" following a channel number indicates simplex use of the ship station transmit side of an international duplex channel. Operations are different from that of international operations on that channel.
2. Channel 16 is used for calling other stations or for distress alerting.
3. The letter "B" following a channel number indicates simplex use of the coast station transmit side of an international duplex channel. That is, the channel is Receive Only.
4. Channel 70 is used exclusively for Digital Selective Calling (DSC) and is not available for regular voice communications.
5. Channels 75 and 76 are reserved as guard bands for Channel 16 and are not available for regular voice communications.

## European Private Channels and Frequencies

In addition to the channels listed above in the International Marine VHF Channels & Frequencies table, your radio may also include some of the following private channels. Which channels are included depend upon the country in which the radio is to be operated and whether you possess the appropriate licensing

Country	CH No.	XMIT Freq	RCV Freq	Freq Use
Belgium	96	162.425	162.425	Marina
Denmark	L1	155.500	155.500	Leisure
	L2	155.525	155.525	Leisure
Denmark, Finland, Norway & Sweden	F1	155.625	155.625	Fishing
	F2	155.775	155.775	Fishing
	F3	155.825	155.825	Fishing
Finland, Norway&Sweden	L1	155.500	155.500	Leisure
	L2	155.525	155.525	Leisure
	L3	155.650	155.650	Leisure
Netherlands	31	157.550	162.150	Marina
	37	157.850	157.850	Leisure
UK	M1	157.850	157.850	Marina
	M2	161.425	161.425	Marina

Note: A license may be required to operate the radio on the private channels. It is your responsibility to obtain the proper license to operate the radio on these frequencies.